

Art. Nr.: **SB.6431733**

Bezeichnung: **64317**

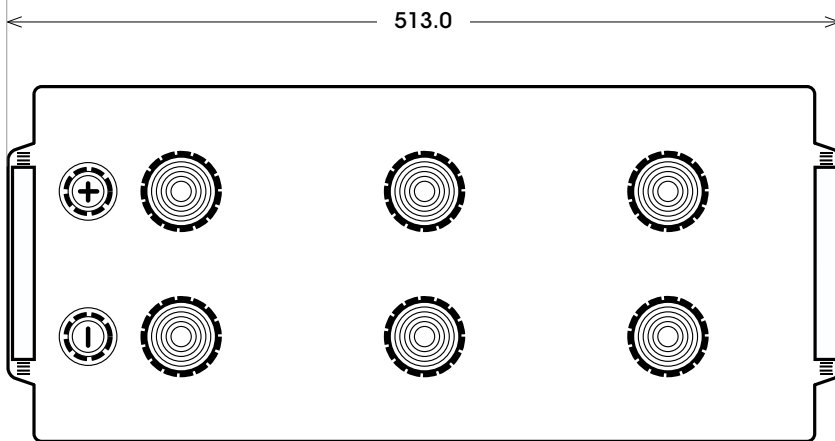
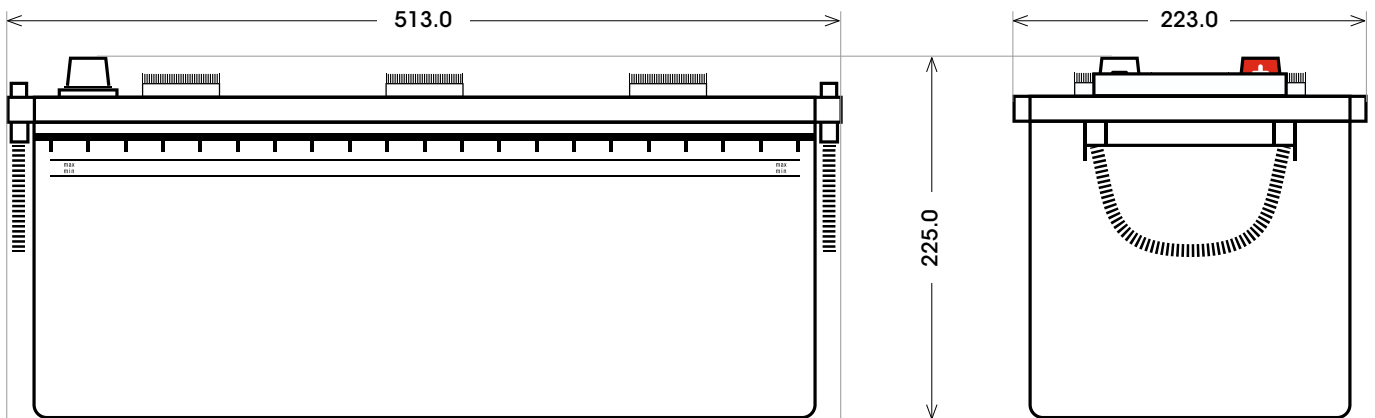

Technologie	Calcium-Calcium
Separator Typ	Envelope
Box-Material	Polypropylen
Boxfarbe	Schwarz
Spannung	12 V
Kapazität	143 Ah
Kälteprüfstrom	900 A/EN
L x B x H (mm)	513 x 223 x 225
Bodenleiste	B00
Schaltung	3
Anschlusspole	1
Gewicht	39.7 kg
Stück/Palette	21
Ausführung	G+G (gefüllt und geladen)

Bodenleiste **B00**



Schaltung **3**

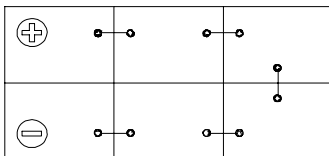

Anschlusspole **1**

