

Art. Nr.: **SB.6403533**

Bezeichnung: **64035**

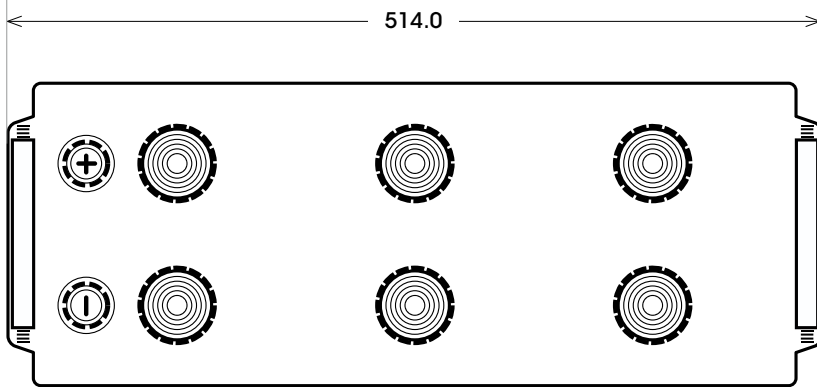
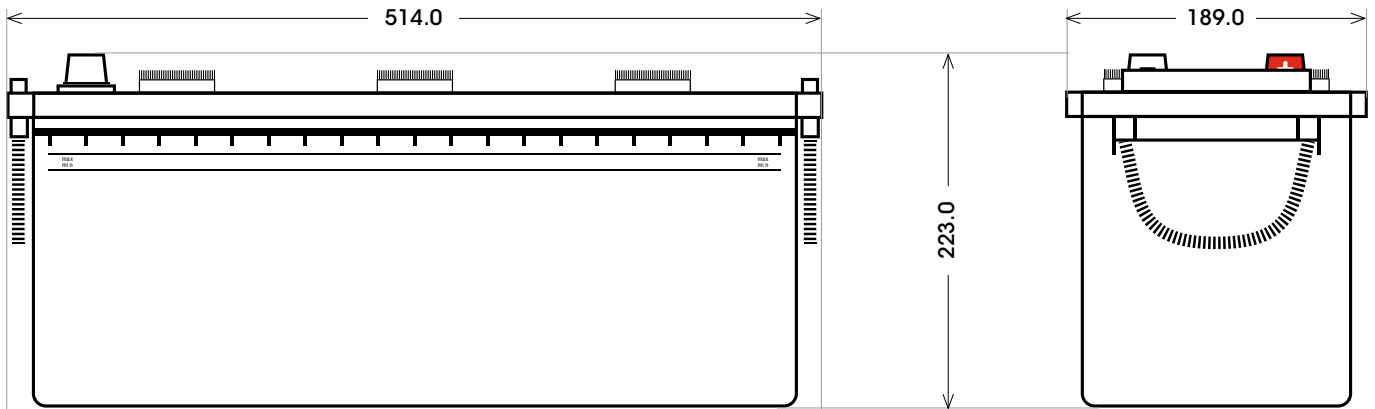

Technologie	Calcium-Calcium
Separator Typ	Envelope
Box-Material	Polypropylen
Boxfarbe	Schwarz
Spannung	12 V
Kapazität	140 Ah
Kälteprüfstrom	760 A/EN
L x B x H (mm)	514 x 189 x 223
Bodenleiste	B00
Schaltung	3
Anschlusspole	1
Gewicht	35.7 kg
Stück/Palette	24
Ausführung	G+G (gefüllt und geladen)

Bodenleiste **B00**



Schaltung **3**

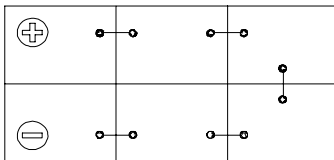

Anschlusspole **1**

