

Art. Nr.: **SB.5452400**

Bezeichnung: **54524**

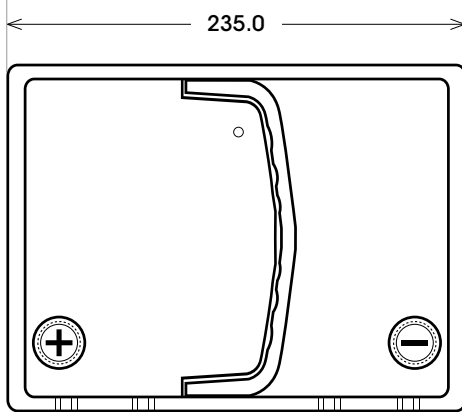
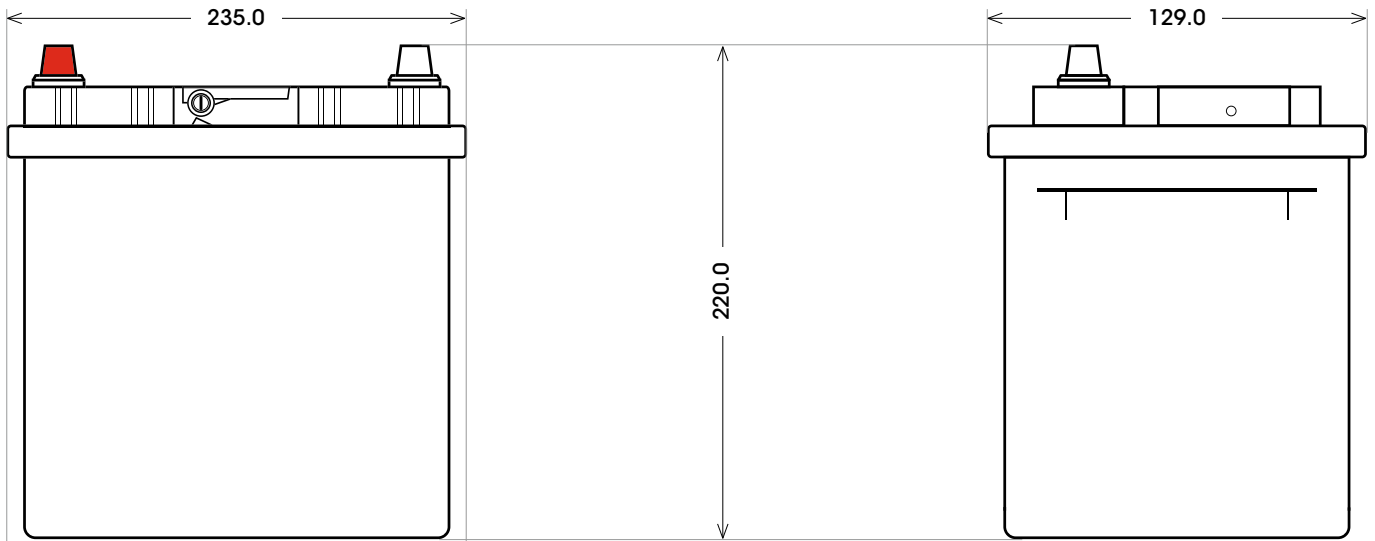

Technologie	Calcium-Calcium
Separator Typ	Envelope
Box-Material	Polypropylen
Boxfarbe	Schwarz
Spannung	12 V
Kapazität	45 Ah
Kälteprüfstrom	300 A/EN
L x B x H (mm)	235 x 130 x 220
Bodenleiste	B00
Schaltung	1
Anschlusspole	1
Gewicht	8.9 kg
Stück/Palette	81
Ausführung	G+G (gefüllt und geladen)

Bodenleiste **B00**

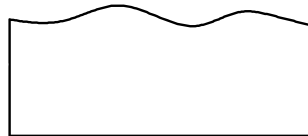

Schaltung **1**

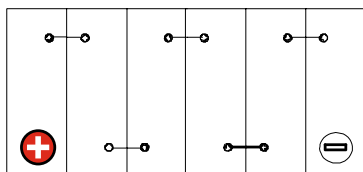

Anschlusspole **1**

