

Art. Nr.: **SB.6052833**

Bezeichnung: **60528**

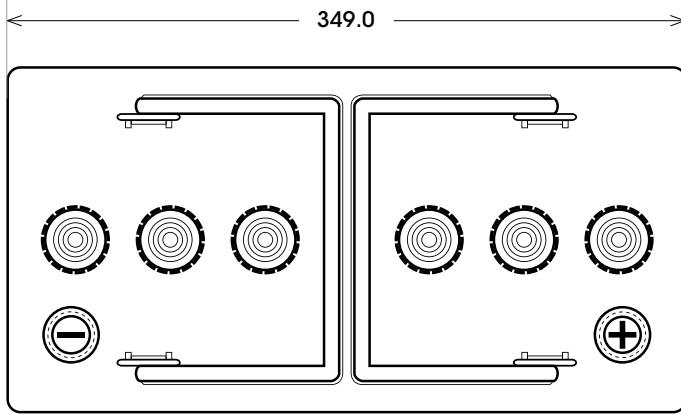
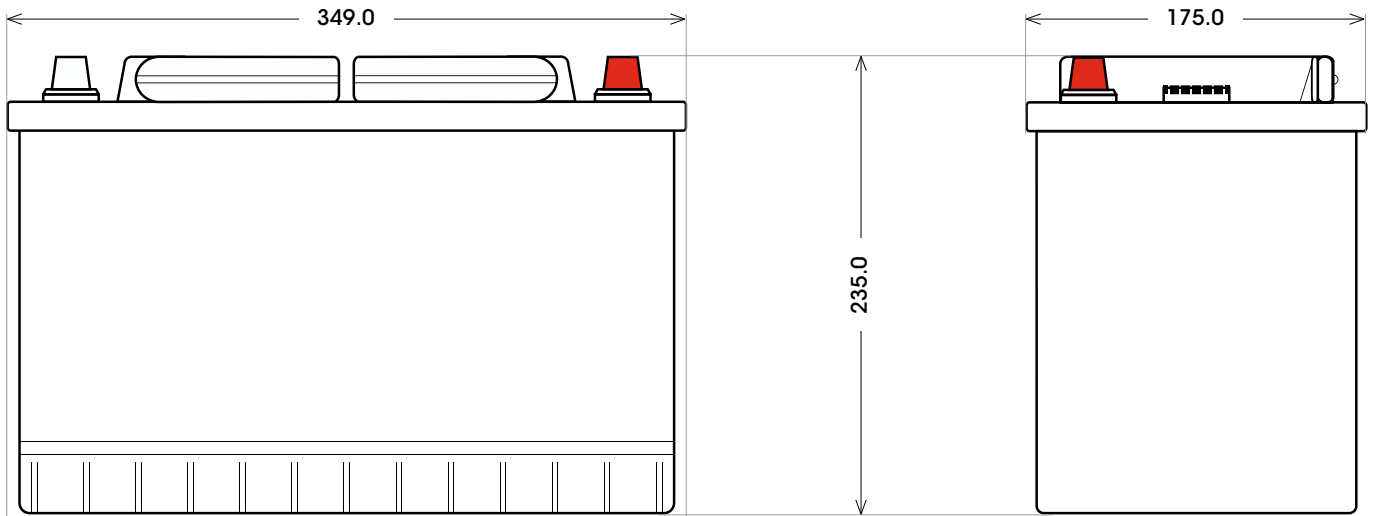

Technologie	Calcium-Calcium
Separator Typ	Envelope
Box-Material	Polypropylen
Boxfarbe	Schwarz
Spannung	12 V
Kapazität	105 Ah
Kälteprüfstrom	680 A/EN
L x B x H (mm)	349 x 175 x 235
Bodenleiste	B00
Schaltung	0
Anschlusspole	1
Gewicht	28.6 kg
Stück/Palette	24
Ausführung	G+G (gefüllt und geladen)

Bodenleiste B00



Schaltung 0

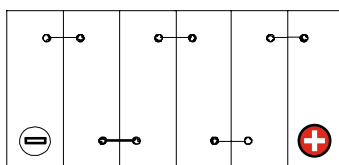

Anschlusspole 1

