

Art. Nr.: **SB.5664133**

Bezeichnung: **56641**

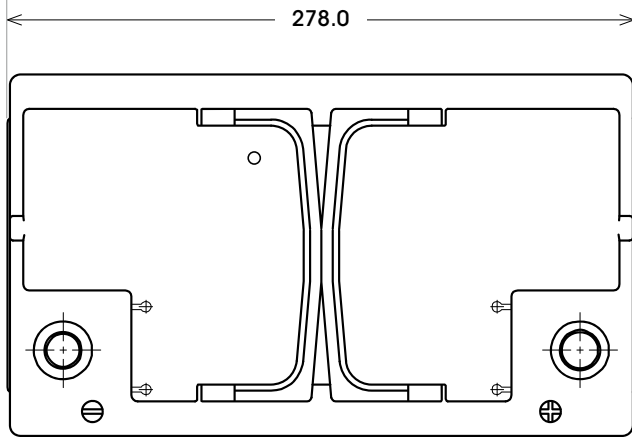
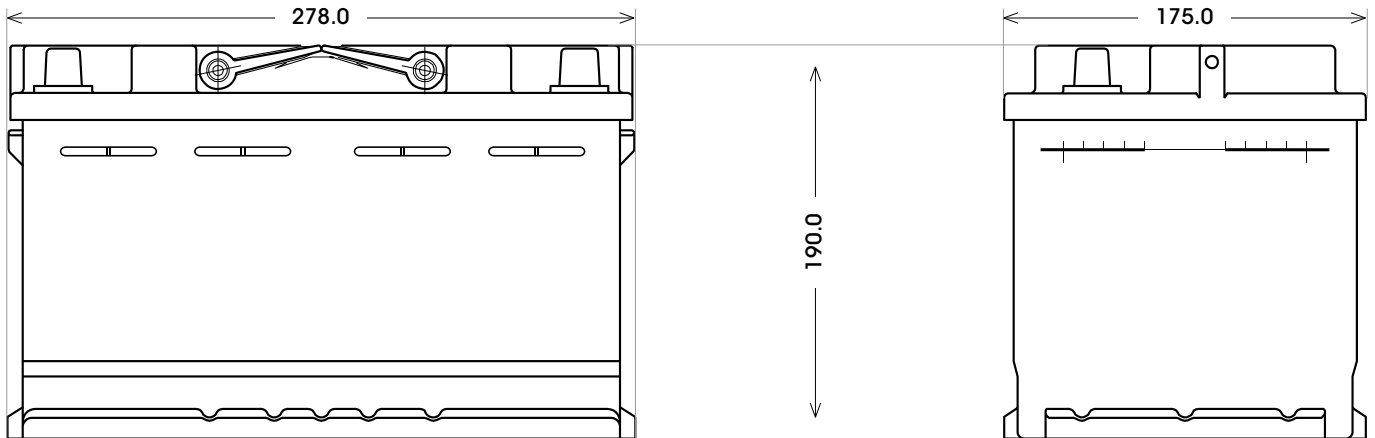

Technologie	Calcium-Calcium
Separator Typ	Envelope
Box-Material	Polypropylen
Boxfarbe	Schwarz
Spannung	12 V
Kapazität	66 Ah
Kälteprüfstrom	510 A/EN
L x B x H (mm)	278 x 175 x 190
Bodenleiste	B13
Schaltung	0
Anschlusspole	1
Gewicht	16.7 kg
Stück/Palette	48
Ausführung	G+G (gefüllt und geladen)

Bodenleiste B13

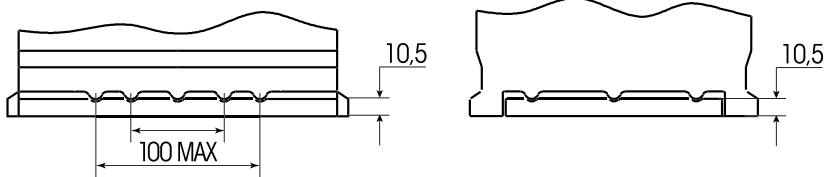

Schaltung 0

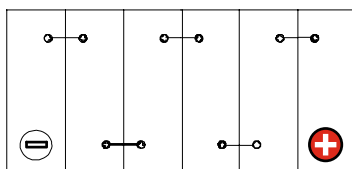

Anschlusspole 1

